

Model G8T-120 W/IEC Electric Motor Rotary Gear Pump Unit

Pump Unit Include:

- Model G8T-120 Rotary gear pump FM Approved.
- UL listed or Non-listed TEFC Type Electric Motor*.
- Curved Jaw Elastomer Coupling.
- Carbon Steel Coupling Guard RAL3000(standard) or other color on request.
- Carbon Steel Base Plate, RAL3000(standard) or other color on request.

* Junction Box located on top or side of motor

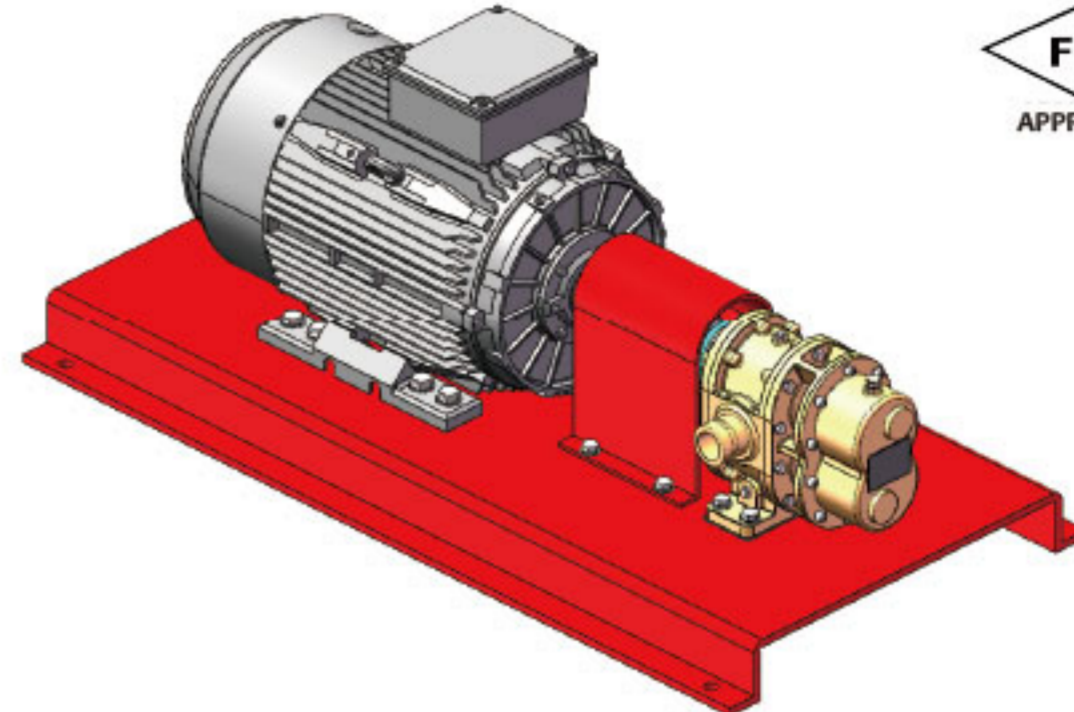

Technical Data:

Speed:	1450RPM
Connection Dia:	DN100(114.3mm O.D)
Connection Type:	Groove, Flange, Thread
Voltage:	380V/3P/50HZ
Enclosure:	IP 56

Performance

Speed	G8T-120	
1500rpm	Flow Rate (Water)	Power
Pressure	L/min	Kw
5.0	899.8	17.00
5.5	894.4	17.80
6.0	889.0	18.60
6.5	883.8	19.39
7.0	878.8	20.18
7.5	873.9	20.97
8.0	869.2	21.76
8.5	864.7	22.56
9.0	860.4	23.36
9.5	856.4	24.17
10.0	852.6	25.00
10.5	849.2	25.84
11.0	845.9	26.70
11.5	843.0	27.57
12.0	840.2	28.45
12.5	837.6	29.34
13.0	835.2	30.25
13.5	833.0	31.17
14.0	830.8	32.10
14.5	828.8	33.05
15.0	826.8	34.00
15.5	824.9	34.96
16.0	823.1	35.94
16.5	821.2	36.92
17.0	819.3	37.91
17.5	817.4	38.91
18.0	815.5	39.91
18.5	813.4	40.92
19.0	811.3	41.94
19.5	809.0	42.97
20.0	806.6	44.00

Speed	G8T-120	
1500rpm	Flow Rate (Foam)	Power
Pressure	L/min	Kw
5.0	863.2	21.00
5.5	861.5	21.90
6.0	859.7	22.82
6.5	858.0	23.73
7.0	856.3	24.65
7.5	854.5	25.56
8.0	852.8	26.47
8.5	851.0	27.37
9.0	849.2	28.26
9.5	847.4	29.14
10.0	845.6	30.00
10.5	843.7	30.84
11.0	841.9	31.66
11.5	840.0	32.47
12.0	838.2	33.27
12.5	836.3	34.06
13.0	834.4	34.85
13.5	832.5	35.63
14.0	830.5	36.42
14.5	828.6	37.20
15.0	826.7	38.00
15.5	824.7	38.81
16.0	822.8	39.62
16.5	820.8	40.46
17.0	818.8	41.31
17.5	816.9	42.19
18.0	814.9	43.09
18.5	812.9	44.02
19.0	810.9	44.98
19.5	808.9	45.97
20.0	806.9	47.00

Model G8T-120 W/IEC Electric Motor Rotary Gear Pump Unit

Dimensions

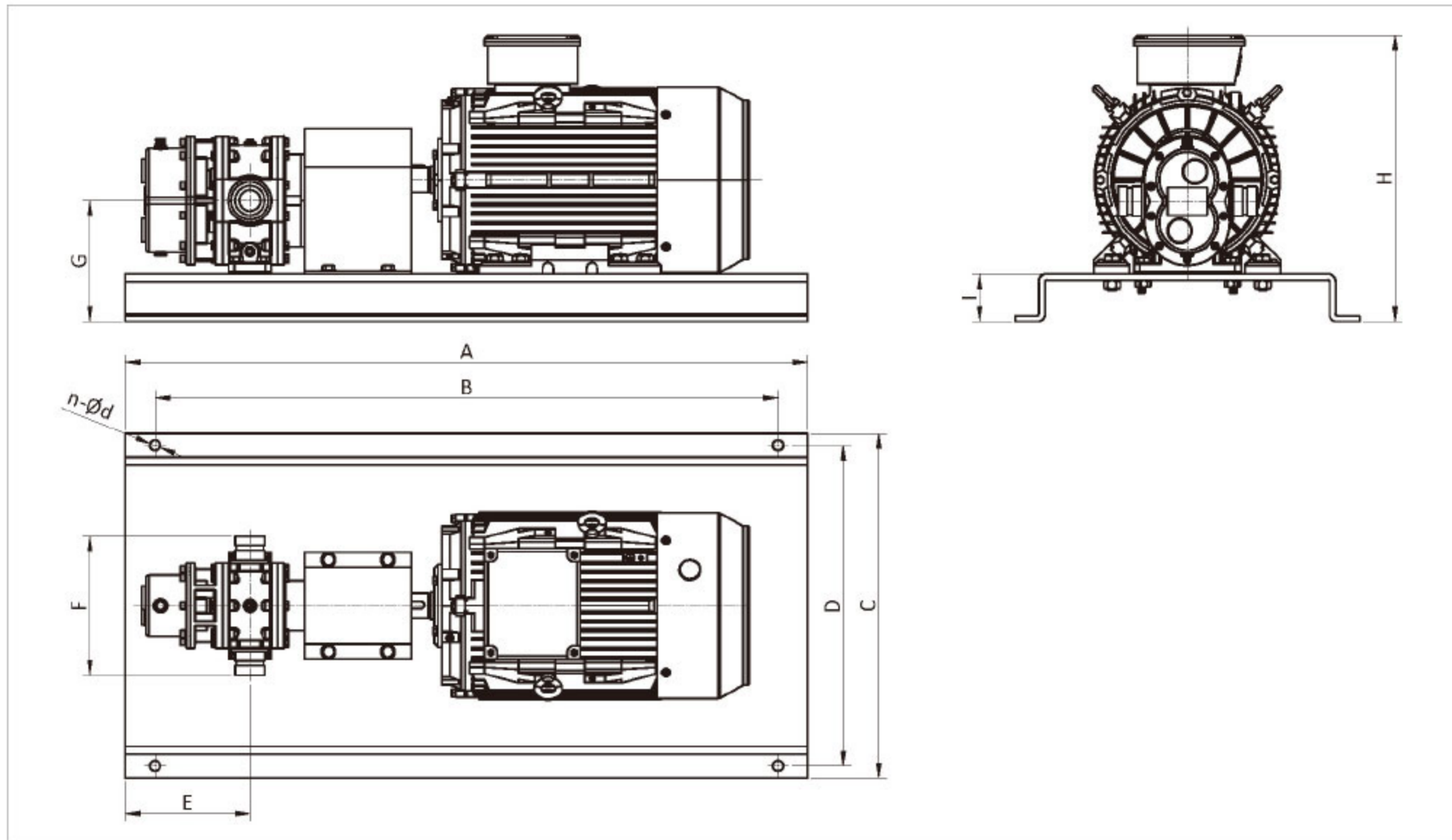

Model	Power	A	B	C	D	E	F	G	H	I	n	d
G8T	Kw	mm	mm	mm	mm	mm	mm	mm	mm	mm	-	mm
	18.5	1380	1380	630	590	300	312	248	568	80	4	18
	22.0	1420	1320	630	590	300	312	248	568	80	4	18
	30.0	1460	1360	700	660	300	312	248	603	80	4	18
	37.0	1500	1400	760	720	300	312	250	637	80	4	18
	45.0	1530	1430	760	720	300	312	250	637	80	4	18
55.0	1600	1500	830	790	300	312	275	696	80	4	18	